

Front Fork

RXC34 m.1

Owner's Manual



ADVANCED SUSPENSION TECHNOLOGY



Öhlins Headquarters Upplands Väsby, Sweden

Öhlins Racing AB - The Story

It was the 1970's, a young man named Kenth Öhlin spent most of his spare time pursuing his favorite sport: motocross.

Being a careful observer, Kenth's attention was continuously drawn to one specific detail - motocross bikes had more engine power than their suspension could handle. It was not long before Kenth realized that better performance could be achieved by improved wheel suspension.

Öhlins Racing was established in 1976, and just two years later the company won its first World Championship title. Despite being in the business for almost 50 years, the search for perfection and new functionalities is still the main focus of the company.

Congratulations! You are now the owner of an Öhlins product. More than 400 World Championships and other major world titles are definitive proof that Öhlins products offer outstanding performance and reliability.

Every product has gone through rigorous testing and engineers have spent thousands of hours, doing their very best to use every possible experience from our almost 50 years in racing.

The product that you now have in your possession is a pure racing breed that is built to last.

By installing this product on your bike, you are making a clear statement: you are a serious rider with a focus on getting the maximal handling ability and outstanding feedback from your bike. Along with that comes the fact that your Öhlins product will be a long-lasting friend, delivering the very best in comfort and performance every time you ride. Now get out there and explore!

SAFETY PRECAUTIONS

General Warnings

⚠ Warning!

After you have installed the Öhlins product, take a test ride at low speed to ensure the bicycle has maintained stability.

⚠ Warning!

If the suspension makes an abnormal noise, the function is irregular, or if you notice any leakage from the product, stop riding the bicycle immediately and return the product to an authorized Öhlins MTB service center.

⚠ Warning!

The product warranty shall only apply if the product has been operated and maintained in accordance with the recommendations in this manual. If you have any questions regarding usage, service, inspection and/or maintenance, please contact an authorized Öhlins MTB service center.

⚠ Warning!

This product was developed and designed for the bike industry and shall only be installed onto related vehicles, including pedal-assisted motorized cycles that produce a maximum of 250 watts of power. DO NOT use Öhlins bicycle suspension products on any throttle-equipped motorized cycles or vehicles carrying more than one operator or rider, such as a tandem bicycle or heavy utility bicycle. Any use outside of these terms must be approved by Öhlins on a case-by-case basis. Any such unauthorized misuse may result in failure of the suspension, which could cause a crash and result in property damage, SERIOUS INJURY OR DEATH, and a voided warranty.

⚠ Warning!

This product contains pressurized air. Do not open, service or modify this product without proper training and tools. All hydraulic servicing must be completed by an authorized Öhlins MTB service center. All other servicing must be completed by an authorized Öhlins MTB service center; alternatively, you can conduct the service yourself if you have the necessary skills, genuine parts and tools. In some cases, the product might need to be sent to another region for service.

🚫 Caution!

Do not use a pressure washer or power washer when cleaning the fork.

👁 Note!

The fork is an important part of the bicycle and will affect the stability.

👁 Note!

Read and ensure you understand the information in this manual and other technical documents provided by the bicycle manufacturer before using the product.

SAFETY SYMBOLS

In this manual, mounting instructions and other technical documents, important information concerning safety is distinguished by the following symbols:

⚠ Warning!

The Warning Symbol means: Failure to follow warning instructions can result in severe or fatal injury to anyone working with, inspecting or using the Product/Fork, or to bystanders.

🚫 Caution!

The Caution Symbol means: Special precautions must be taken to avoid damage to the Product/Fork.

👁 Note!

The Note Symbol indicates important information regarding procedures.

👁 Note!

Öhlins Racing AB cannot be held responsible for any damage to the shock absorber, bicycle, other property or injury to persons, if the instructions for mounting, usage and maintenance are not followed exactly.

👁 Note!

When working with the Öhlins product, always read the bicycle manufacturer's manuals.

👁 Note!

This manual shall be considered as a part of the product and shall therefore accompany the product throughout its life cycle.

👁 Note!

Please retain the original packaging for warranty and service needs.

👁 Note!

Please note that during transportation and storage, especially at high ambient temperatures, some of the oil and grease used for assembling may leak and stain the packaging. This is in no way detrimental to the product, you can just wipe off the oil/grease with a cloth.

👁 Note!

Please note that the images in this manual are a general representation of the product and may differ slightly from your product.

👁 Note!

Maximum system weight (including rider, bike and gear) 135 kg.



THE ÖHLINS RXC34 m.1 FRONT FORK

Congratulations on your excellent choice of purchasing this high-performance Öhlins front fork.

This product is designed for the upcoming, next generation of stars and has been developed by Öhlins' mountain bike department in Sweden, with their experience from working with the world stars of today.

We recommend that you read this manual carefully so you can achieve the proper bike setup and get the best possible performance out of your suspension components.

Contents

1 How it works	5
2 Mounting instructions	6
3 Air spring setup	9
4 OTX14 Setup	14
5 Maintenance	17

1 HOW IT WORKS

When setting up the new product, you need to consider both the front fork and shock absorber. To achieve the correct setup, the front fork and shock absorber must be in balance.

When you set up the fork, there are two systems to consider:

Spring

The main purpose of the spring is to support the rider and bike and restore the set ride height after impact.

Setting up your sag is the most important aspect of tuning your fork, and this is done by correctly tuning your air spring. Sag is the percentage of suspension travel that is used when you assume a normal, static riding position on the bike. See Specify the chapter instead for air spring setup procedure.

Hydraulic damping

The damping controls the fork's movement in compression and rebound by converting the kinetic energy into heat. Valves and shim stacks are used to regulate the oil flow and thus control the amount of damping.

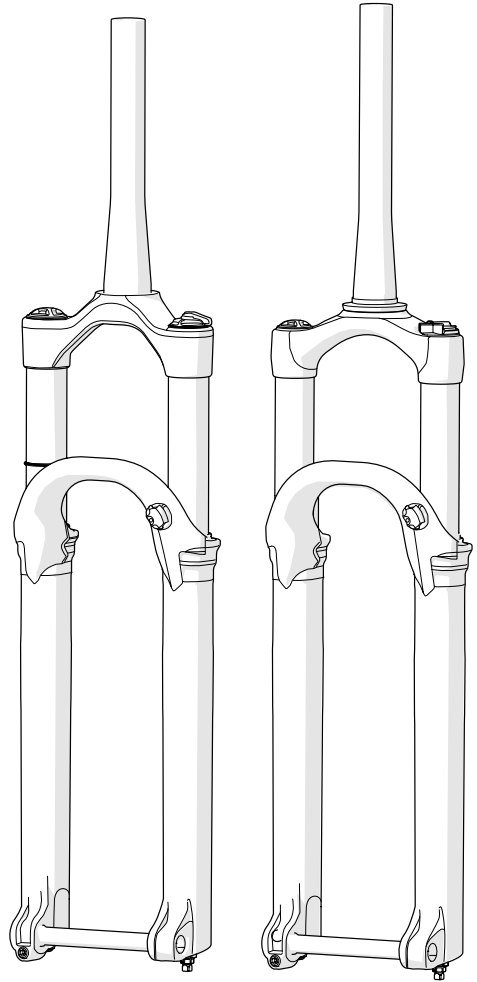

2 MOUNTING INSTRUCTIONS

⚠ Warning!

It is advisable to have an authorized Öhlins MTB service center install the front fork.

⚠ Warning!

If the bicycle is mounted in a work stand, please be sure to hold the frame when front fork is removed to prevent damage to paint and/or finish.

👉 Caution!

Press-fit crown races, e.g. crown races with integrated steerer stop, should be pressed or hammered into position with the bottom of the steerer tube as the support. The end of the steerer tube must be firmly supported and no other part of the fork can bear any load during this operation.

👁 Note!

Before installing this product, clean the bicycle thoroughly.

RXC34 m.1 (alloy crown)

1

Remove the original front fork.

2

Place the front fork on the bike. Install stem and tighten headset according to the manufacturer's instructions.

Go to Step 4 to continue.

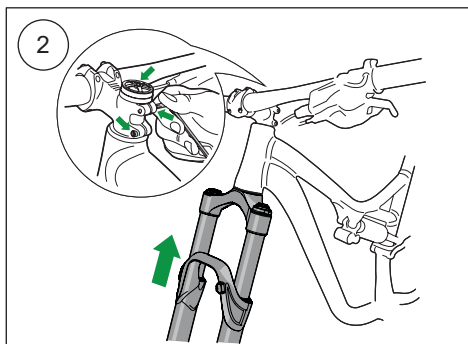
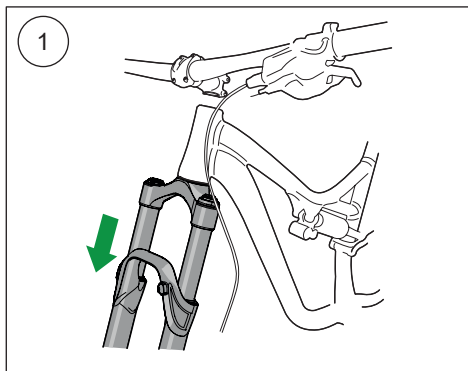

2 MOUNTING INSTRUCTIONS

⚠ Warning!

Never use anything other than the steerer tube expander supplied by Öhlins for carbon fiber steerer tubes.

⚠ Warning!

Cutting of carbon fiber steerer tubes should be performed by a trained professional.

⚠ Warning!

It is advisable to have an authorized Öhlins MTB service center install the front fork.

⚠ Warning!

If the bicycle is mounted in a work stand, be sure to hold the frame when front fork is removed to prevent damage to paint and/or finish.

👁 Note!

Before installing this product, clean the bicycle thoroughly.

RXC34 m.1 Carbon

1

Remove the original front fork.

2

Place the front fork on the bike.

- 2.1 Insert expander into steerer tube.
- 2.2 Torque the expander with a 6 mm hex key to 8 Nm while holding the expander body with an adjustable wrench.
- 2.3 Torque the headset and stem according to the manufacturer's recommendations. Maximum spacer height above stem: 10 mm.

3

Install stem and tighten headset according to manufacturer's instructions.

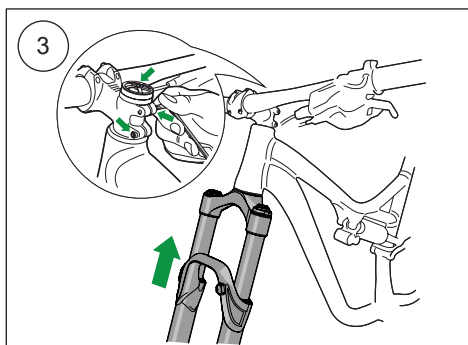
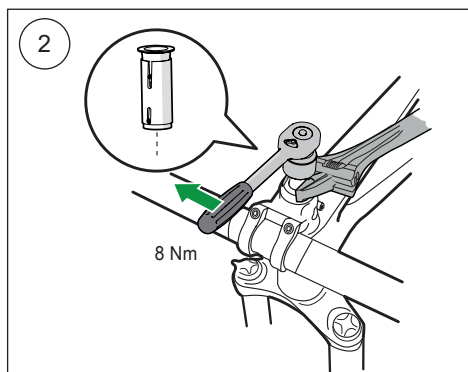
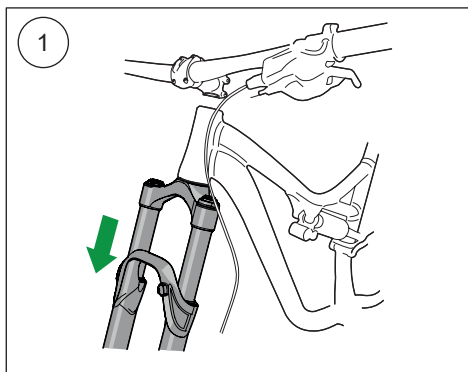

2 MOUNTING INSTRUCTIONS

3

Install the brake caliper according to the brake manufacturer's instructions. Minimum rotor size 160 mm, maximum rotor size 203 mm.

4

Attach the brake cable to the hose clamp and tighten the screw. Use a 2.5 mm hex key. Tighten the bolt to 0.5 Nm.

5

Apply grease on wheel shaft and shaft threads before installation. Use a 5 mm hex key to tighten the wheel shaft A before screw B. Forks with remote, tighten A and B to 6 Nm.

6 (Forks with remote)

Install the remote connection wire. Use a 1.5 mm hex torque wrench to tighten the set screw to 0.4 Nm. Make sure there is no slack in the wire and that the ends of the cable housing are inserted all the way into the holders.

7 (Forks with remote)

Use a 5 mm hex key to adjust the pretension on the wire. Adjust until placing the remote lever in lockout mode results in a stiff feeling in the fork while trying to compress it.

⚠ Caution!

Make sure all screws are tightened to the correct torque and that nothing interferes with or restricts movement of the front fork when the suspension is fully compressed or extended. Please check for suitable clearance between the fork and frame when turning.

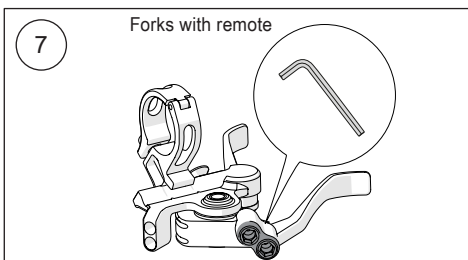
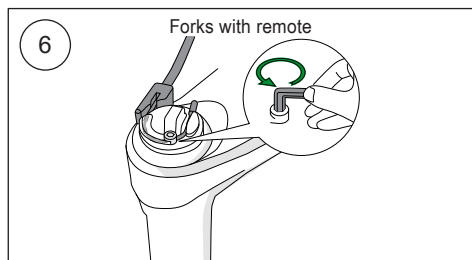
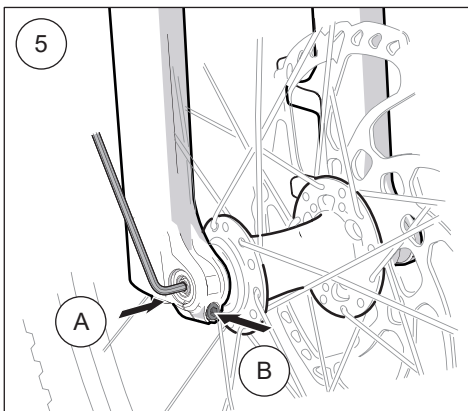
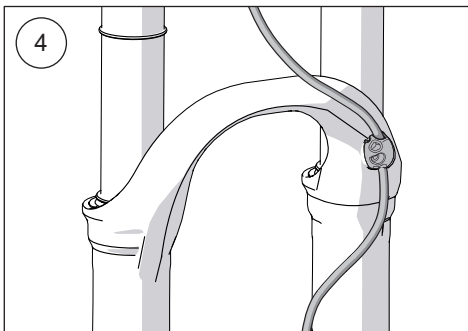
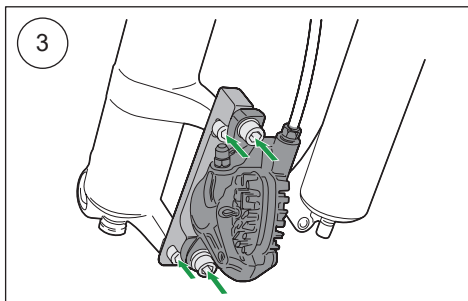

3 AIR SPRING SETUP

Spring pressure setup

A correct spring setup is the most important part of setting up your fork. Start with the recommended pressure and sag and go through the tuning steps described below. It is not possible to fully compensate for a poorly set up air spring by adjusting the damping system.

Setting sag is a crucial part of setting your bicycle since it affects the height of the bicycle and the fork angle. In the following chapter, we will explain how to set the sag. Please refer to the pressure recommendations in table to the right.

Note!

This procedure must be performed on a flat surface. Do not jump or bounce on your bicycle, as this will result in an inaccurate sag measurement.

Setting sag:

1

Unscrew top air cap (main chamber) and attach the shock pump. Pump to desired pressure. Disassemble the air pump and reinsert the compression air cap.

2

Set the O-ring (sag indicator) at the position shown in the to illustration.

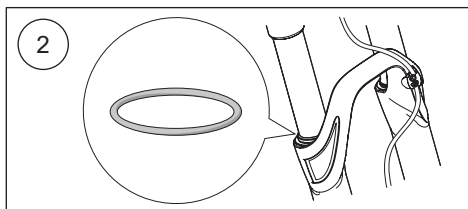
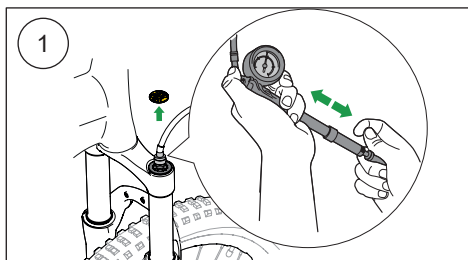

Rider weight	Air pressure
50 - 55 kg (110 - 121 lbs)	58 - 73 PSI
55 - 60 kg (121 - 132 lbs)	63 - 77 PSI
60 - 65 kg (132 - 143 lbs)	67 - 82 PSI
65 - 70 kg (143 - 154 lbs)	72 - 86 PSI
70 - 75 kg (154 - 165 lbs)	76 - 91 PSI
75 - 80 kg (165 - 176 lbs)	81 - 95 PSI
80 - 85 kg (176 - 187 lbs)	85 - 100 PSI
85 - 90 kg (187 - 198 lbs)	90 - 104 PSI
90 - 95 kg (198 - 209 lbs)	94 - 109 PSI
95 - 100 kg (209 - 220 lbs)	99 - 113 PSI
100 - 105 kg (220 - 232 lbs)	103 - 118 PSI
105 - 110 kg (232 - 243 lbs)	108 - 122 PSI
110 - 115 kg (243 - 254 lbs)	112 - 127 PSI
115 - 120 kg (254 - 265 lbs)	117 - 131 PSI

3 AIR SPRING SETUP

3

Dressed in full riding gear, assume your normal riding position on the bicycle.

4

Step off the bicycle and measure the distance the O-ring (sag indicator) has moved. Sag should be set to approximately 15-25% of the fork travel.

General recommendations:

- too little sag: release air from main chamber
- too much sag: fill the main chamber with more air

General recommendations:

Heavy, hard-charging riders may require less sag, while a smoother rider may benefit from more sag. If you have any questions, contact an authorized Öhlins MTB service center for advice.

Use The Performance Suspension Guide (PSG) to find the base set up recommendations air pressure for your specific bike.

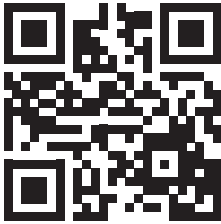
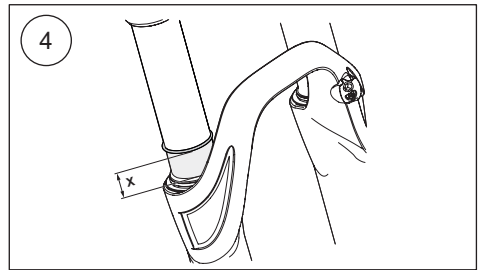
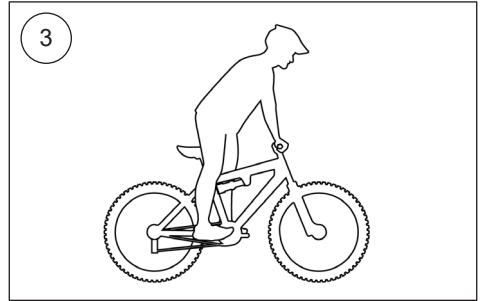

<https://www.ohlins.com/performance-suspension-guide/>

3 AIR SPRING SETUP

Adjusting volume

Adjusting the air spring volume by adding or removing volume spacers affects the ramp characteristics of the spring. Air pressure needs to be adjusted when changing the volume in order to maintain the same sag force.

Adding spacers to the positive chamber will increase the end stroke spring rate.

Adding spacers to the negative chamber will slightly increase the spring rate in the initial part of the stroke and decrease the end stroke rate. Adjusting the negative volume must be performed by an authorized Öhlins MTB service center.

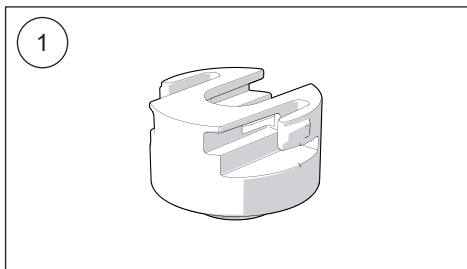

Stroke length	Positive		Negative	
	Recommended	Max	Recommended	Max
100	1 x 8 ml	4 x 8 ml	4 x 1 ml	7 x 1 ml
110	3 x 8 ml	5 x 8 ml	4 x 1 ml	7 x 1 ml
120	2 x 8 ml	5 x 8 ml	4 x 1 ml	7 x 1 ml
130	1 x 8 ml	4 x 8 ml	4 x 1 ml	7 x 1 ml

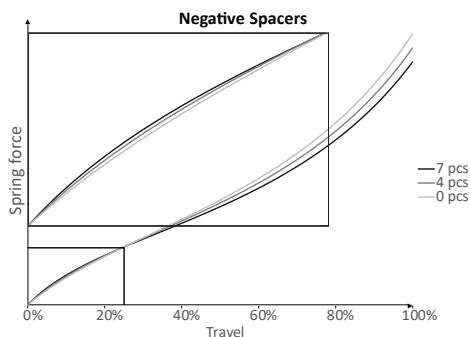
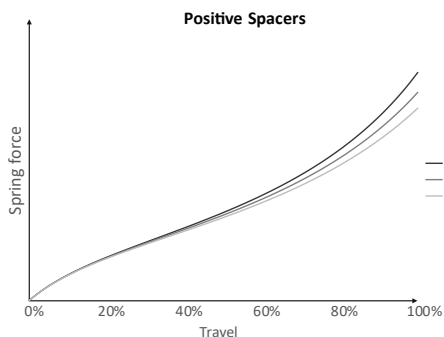

3 AIR SPRING SETUP

⚠ Warning!

Make sure all pressure is released from the air spring before you start to work on it.

⚠ Warning!

Never install more spacers than the maximum specified amount.

1

Make sure the area around the top cap is completely clean.

2

Release all the air from the air spring.

3

Use a socket wrench with a cassette locking socket tool to loosen the top cap.

4

Pull the top cap and volume spacers from the stanchion.

5

Add/remove volume spacers from the top cap.

6

Make sure the top cap O-ring is free from debris and damage. If the O-ring is damaged, contact an authorized Öhlins MTB service center.

7

Push the volume spacers and top cap back into the stanchion.

8

Use a torque wrench with a cassette locking tool to tighten the top cap to 32 Nm.

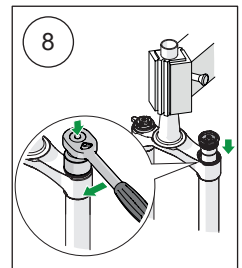
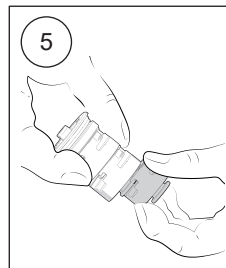
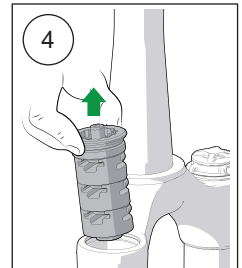
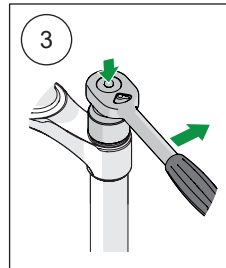
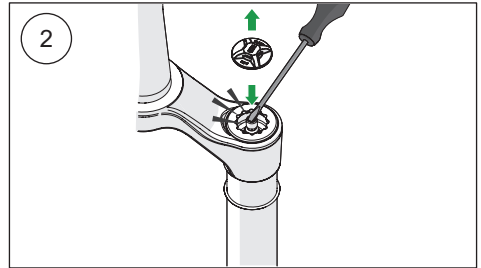

3 AIR SPRING SETUP

Reset to original ride position

After reducing the air pressure in the main chamber, it is necessary to reset the fork to its original length.

Example: If you are lowering the pressure from 90 PSI to 70 PSI, the fork will get a lower ride position (shorter travel). Reset the fork to original ride position by extending the fork, pulling the handlebars up while your friend holds the wheel tight to the ground. Repeat the extension about 10 times, until you have reached the original length.

Original fork lengths:

Fork travel [mm]	Wiper seal to crown [mm]	Axle to crown [mm]
100	102	511
110	112	521
120	122	531
130	132	541

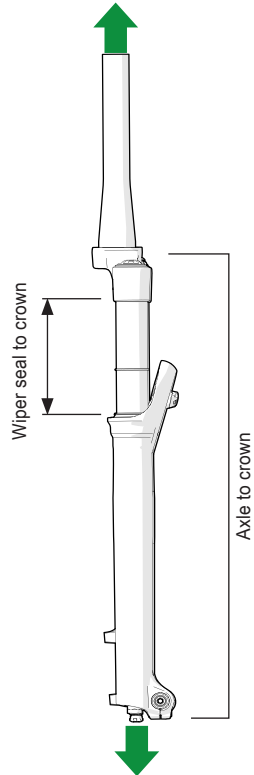

4 OTX14 SETUP

Compression damping controls the energy absorption when the front fork is being compressed, thereby controlling how easily the front fork compresses when you hit a bump. Rebound damping controls the energy absorption when the front fork is being extended and controls how fast the front fork returns to its normal position after being compressed.

To set the adjusters

Turn the adjuster clockwise to the fully closed position. Then, turn counterclockwise to open, and count the clicks until you reach the recommended number of clicks.

⚠ Caution!

Turn gently to avoid damaging delicate sealing surfaces. Tighten with your hand only.

Low speed compression adjuster

To adjust, turn the blue colored adjuster on the top of the OTX cartridge. Turn clockwise to increase damping, turn counterclockwise to decrease. The low speed adjuster will only affect the damping in ride mode 1.

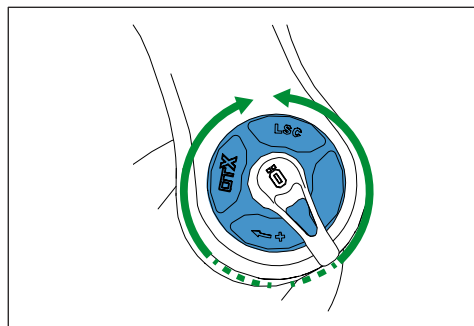

Ride mode selection

To switch between ride modes use the black lever or the remote adjuster. There are three different modes:

1. Open
2. Pedal mode
3. Lock out

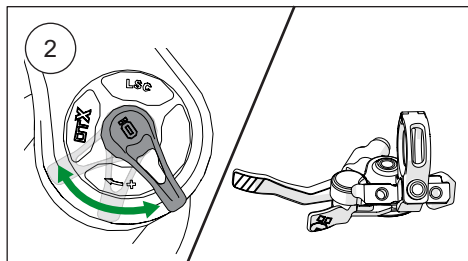

Rebound damping adjuster

Adjust rebound

Turn the gold colored adjuster on the end eye/ bracket. Turn clockwise to increase damping, turn counterclockwise to decrease.

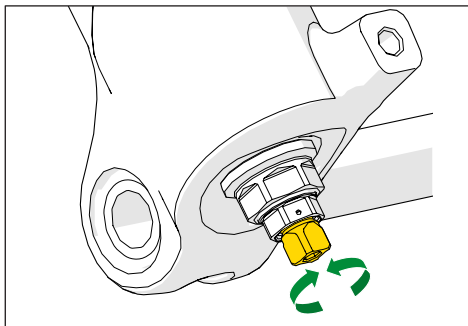

4 OTX14 SETUP

Stability and traction

All bicycles are designed with a suspension geometry that includes height and fork angle. Changing any components may affect the suspension geometry and it is therefore essential that the front and rear ends match each other. Changing to Öhlins suspension gives optimal performance only when both the front fork and the rear suspension interact properly. It is very important that the front and the rear ride heights are within the specified values.

General setup

By adjusting the front fork and testing by trial and error you can learn how the different settings affect your bicycle. Always begin your setup process by taking a test ride with all adjustments at their recommended basic settings. Choose a short run of varying character, where there are both long and sharp bends, as well as hard and soft bumps. Stay on the same run and adjust only one setting at a time.

When you set up your bicycle you need to do it together with the front fork and on all types of tracks that you want to optimize. There are no setups that will be 100% perfect on all tracks and some compromises will need to be made.

However, you should always prioritize

- safety
- stability
- comfort

This will allow you to ride safer, with more confidence and use less energy.

Adjustment range

The RXC fork is designed for use within the full adjustment range, and using the front fork fully open or closed is normal for some riders.

Rebound damping

If the bike feels loose, nervous over bumpy sections and kicking in jumps, close the rebound adjuster one click.

If the bicycle has a hard, harsh feeling, 'packs down' over bumps, is difficult to enter corners with or does not stay in line over bumpy sections, open the rebound adjuster 1 click

- unstable
 - loose
 - bouncy
- Increase rebound damping

If the bicycle feels

- hard
 - nervous
 - low traction
- Decrease rebound damping

4 OTX14 SETUP

Low speed compression damping

The low speed adjuster is used for controlling the chassis movement towards the ground.

If you feel that the front fork feels soft, spongy, or the bicycle feels unstable (for example when going into a corner), close 1 click (clockwise).

If you feel that the bicycle feels hard and has poor traction, open 1 click (counterclockwise).

Ride modes

Position 1,

Open. To be used when maximum traction and control is needed. In this mode it is possible to further fine-tune the amount of compression damping with the low speed compression adjuster.

Position 2,

Pedal. Adjusts initial movement in the damper to increase pedal efficiency. Helps to carry momentum and reduce fatigue while supporting tire traction, even on rough terrain. Maximizes overall efficiency when riding over choppy surfaces.

Position 3,

Lockout. To be used on flat terrain when no suspension is needed. Maximizes pedal efficiency.



5 MAINTENANCE

Extreme riding in adverse weather conditions or lack of cleaning will shorten service intervals.

Maintenance	Interval
Clean dirt and debris from front fork	Every ride
Check air pressure and set sag	Every ride
Check torque on front fork mounting bolts	Every ride
Remove lowers, clean and inspect bushings and seals, change oil bath if necessary	50 hours
Full front fork air spring service	100 hours/1 year
Remove and clean lowers, replace seals, change oil bath	100 hours/1 year
Full front fork damping cartridge service	100 hours/1 year

Your Öhlins retailer:

Öhlins Racing AB
Box 722
SE-194 27, Upplands Väsby
Sweden

Phone: +46 (0)8 590 025 00
Fax: +46 (0)8 590 025 80
www.ohlins.com

